

COMBINED SCIENCE

5129/11

Paper 1 Multiple Choice

October/November 2017

1 hour

Additional Materials: Multiple Choice Answer Sheet
Soft clean eraser
Soft pencil (type B or HB is recommended)



READ THESE INSTRUCTIONS FIRST

Write in soft pencil.

Do not use staples, paper clips, glue or correction fluid.

Write your name, Centre number and candidate number on the Answer Sheet in the spaces provided unless this has been done for you.

DO NOT WRITE IN ANY BARCODES.

There are **forty** questions on this paper. Answer **all** questions. For each question there are four possible answers **A, B, C** and **D**.

Choose the **one** you consider correct and record your choice in **soft pencil** on the separate Answer Sheet.

Read the instructions on the Answer Sheet very carefully.

Each correct answer will score one mark. A mark will not be deducted for a wrong answer.

Any rough working should be done in this booklet.

A copy of the Periodic Table is printed on page 16.

Electronic calculators may be used.

This document consists of **16** printed pages.

- 1 All living things, animals and plants, are made up of basic units called cells.

Which feature is found in both animal and plant cells?

- A cell wall
- B chloroplasts
- C large sap vacuole
- D nucleus

- 2 The diagram represents how some red blood cells change when they are placed in solution X.

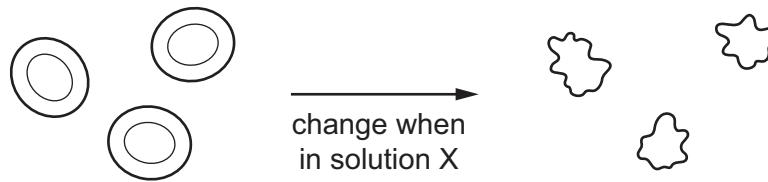

What describes the water concentration in solution X and in which direction does water move?

	water concentration in solution X	direction of water movement
A	higher than in cells	into the cells
B	higher than in cells	out of the cells
C	lower than in cells	into the cells
D	lower than in cells	out of the cells

- 3 The graph shows the effect of temperature on an enzyme controlled reaction.

At which point has the shape of the enzyme completely changed?

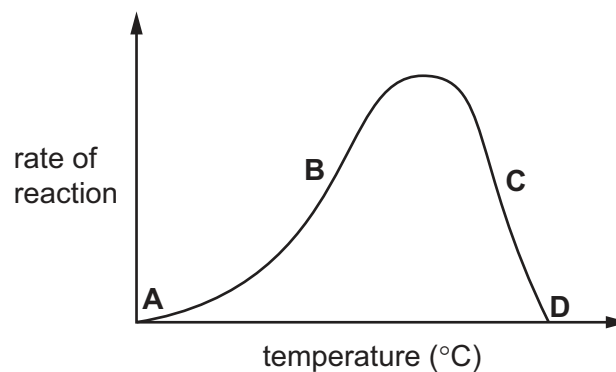

- 4 The diagram shows an experiment which measures the gas given off by a water plant during photosynthesis. Temperature is kept constant. Light intensity is varied by changing the distance between the lamp and the plant.

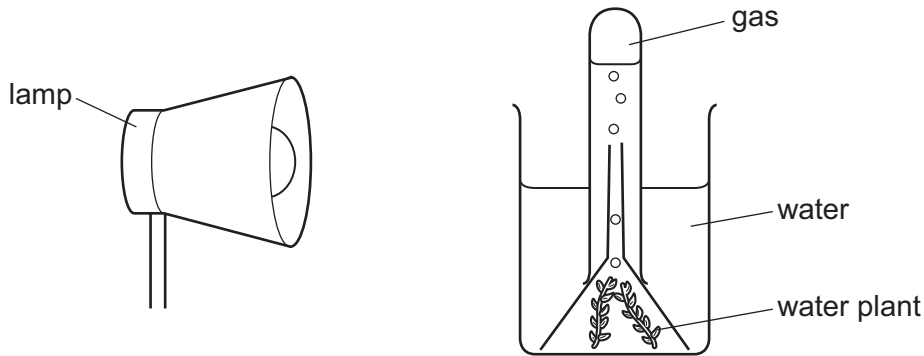

At which distance between the lamp and the plant is the most gas collected in a given period of time?

- A** 10 cm **B** 25 cm **C** 40 cm **D** 75 cm
- 5 When a child sucks a sweet it may stay in their mouth for some time.
How does this contribute to tooth decay?
- A** The sugar in the sweet stops bacteria from growing.
B The teeth are damaged by acid being produced in the mouth.
C The teeth are damaged by alkali being produced in the mouth.
D The teeth are damaged by artificial flavourings in the sweet.
- 6 Xylem and phloem tissues are found in plants.

Which row is correct?

	phloem	xylem
A	transports sugars from the leaves to other parts of the plant	transports water from the roots to the leaves
B	transports sugars to the leaves from other parts of the plant	transports water from the leaves to the roots
C	transports water from the leaves to the roots	transports sugars to the leaves from other parts of the plant
D	transports water from the roots to the leaves	transports sugars from the leaves to other parts of the plant

7 Which vessel contains valves?

- A artery
- B capillary
- C vein
- D xylem

8 A student investigates how the depth of each breath and breathing rate changes as a result of exercise. The table shows her results.

	depth of each breath / cm ³	breathing rate / breaths per minute
at rest	500	16
during exercise	1000	42

What do the student's results show?

- A Exercise decreases the depth of each breath and decreases the breathing rate.
 - B Exercise decreases the depth of each breath and increases the breathing rate.
 - C Exercise increases the depth of each breath and decreases the breathing rate.
 - D Exercise increases the depth of each breath and increases the breathing rate.
- 9 The table shows the direction of flow of two substances that pass between the capillaries and tissue in a part of the body.

substance	direction of flow
amino acids	out of capillaries into tissue
urea	into capillaries from the tissue

In which part of the body are these capillaries?

- A colon
- B kidney
- C liver
- D villi

10 Which row correctly describes a hormone?

	works on	destroyed by
A	gland	kidney
B	gland	liver
C	target organ	kidney
D	target organ	liver

11 Which statement about alcohol is correct?

- A** It improves self-control.
- B** It is a depressant.
- C** It is broken down by the kidneys.
- D** It is not addictive.

12 In the diagram, arrows represent the movement of carbon compounds in the carbon cycle.

The circles represent the locations of carbon compounds in animals, decomposers, plants and in the air.

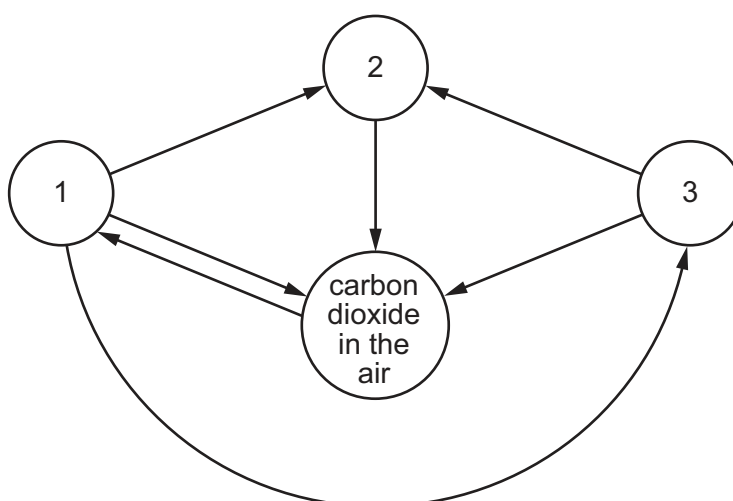

Which location of carbon compounds is represented by each circle?

	1	2	3
A	animals	plants	decomposers
B	decomposers	animals	plants
C	plants	animals	decomposers
D	plants	decomposers	animals

13 Which row describes what happens in asexual reproduction?

	number of parents	gametes produced
A	1	no
B	1	yes
C	2	no
D	2	yes

14 Which apparatus is used to separate and collect the water from a mixture of water and an insoluble powder?

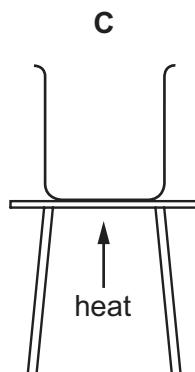
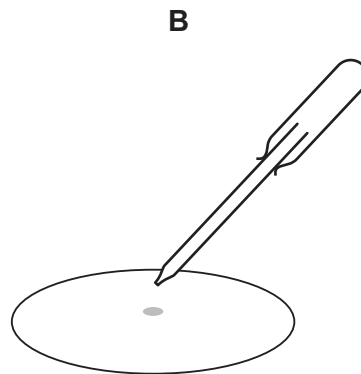
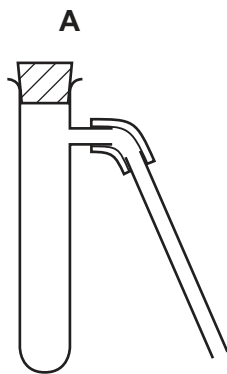

15 Which diagram represents a mixture of gases?

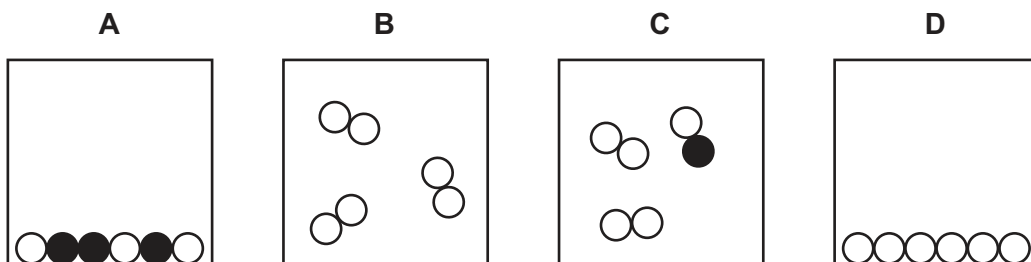

16 The table shows the numbers of particles in three atoms X, Y and Z.

	protons	neutrons	electrons
X	8	8	8
Y	8	9	8
Z	8	10	8

Which statements about X, Y and Z are correct?

- 1 They will have the same chemical properties.
- 2 They will have different physical properties.
- 3 They are all isotopes of the same element.

A 1, 2 and 3 **B** 1 and 2 only **C** 1 and 3 only **D** 2 and 3 only

17 The outer-shell electrons of four atoms are shown.

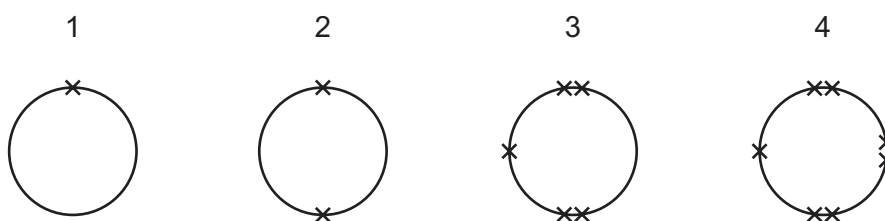

Which two atoms form an ionic compound with a formula XY_2 ?

A 1 and 3 **B** 1 and 4 **C** 2 and 3 **D** 2 and 4

18 Elements P and Q combine to form the gas PQ_2 .

What are P and Q?

	P	Q
A	calcium	chlorine
B	carbon	hydrogen
C	carbon	oxygen
D	hydrogen	oxygen

19 The equation for the decomposition of calcium carbonate is shown.



Which mass of calcium oxide is produced from 10.0 g of calcium carbonate?

A 4.4 g **B** 5.0 g **C** 5.6 g **D** 10.0 g

20 Barium oxide reacts with hydrochloric acid.

What are the products of the reaction?

- A barium chloride and carbon dioxide
- B barium chloride and hydrogen
- C barium chloride and oxygen
- D barium chloride and water

21 Elements in Group VII of the Periodic Table are known as the halogens.

The elements exist as covalent molecules.

What word describes these molecules?

- A amphoteric
- B diatomic
- C inert
- D organic

22 Which row describes properties of a metal?

	property 1	property 2
A	shiny grey solid	conducts electricity when melted but not when solid
B	conducts electricity when solid	can be beaten into shape
C	is in Group VII of the Periodic Table	shiny grey element
D	solid element with a high melting point	crumbles to a powder when crushed using a mortar and pestle

23 Iron is extracted from its ore using carbon.

Aluminium cannot be extracted from its ore using carbon.

Which statement explains why iron is extracted using carbon?

- A Iron is less reactive than aluminium.
- B Iron is less reactive than carbon.
- C Iron is more dense than aluminium.
- D The melting point of iron is more than that of aluminium.

- 24 A mixture of ethene, oxygen and sulfur dioxide is passed through the apparatus as shown. Only one of the gases is collected.

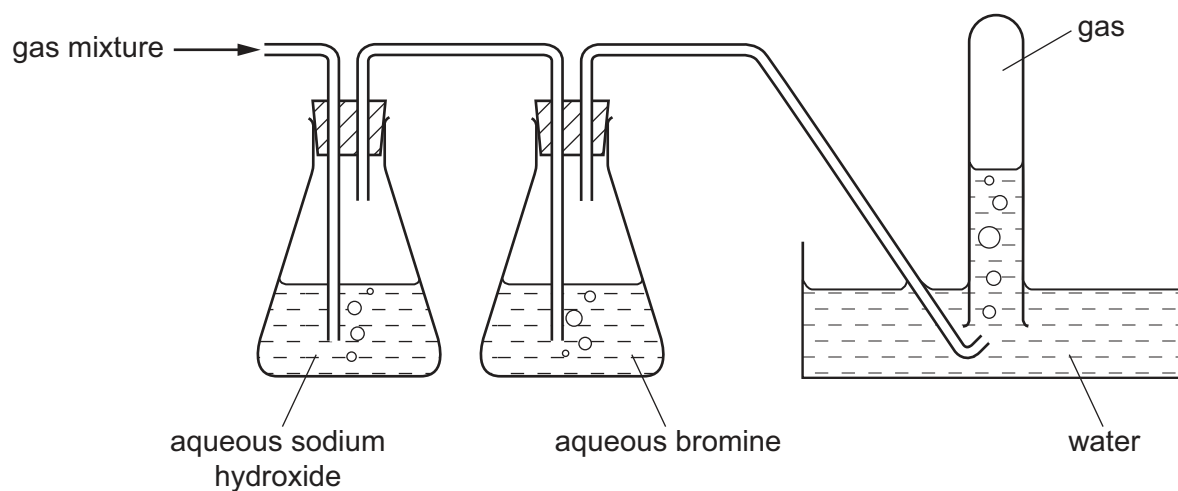

What is a property of the gas collected?

- A It burns with a yellow flame.
 - B It relights a glowing splint.
 - C It turns limewater cloudy.
 - D It turns Universal Indicator red.
- 25 The diagrams show the structures of four organic molecules.

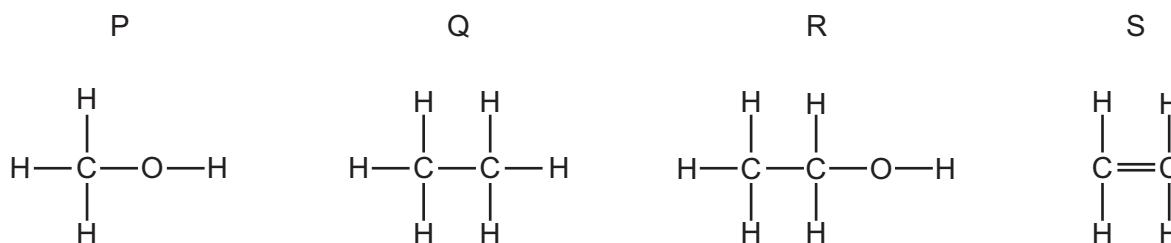

Which two are members of the same homologous series?

- A P and R
- B P and S
- C Q and R
- D R and S

- 26 Ethane gas is heated to produce hydrogen gas and another gas Y which decolourises aqueous bromine.

What is the structural formula of Y?

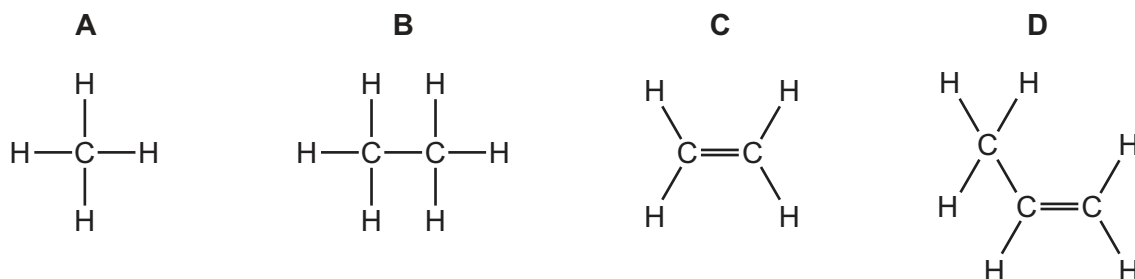

- 27 The fermentation of glucose produces ethanol and which other product?

- A** carbon dioxide
B hydrogen
C oxygen
D water

- 28 A speed-time graph may show an object at rest, moving with constant acceleration and moving with a constant speed above zero.

Which graph shows **all three** types of motion?

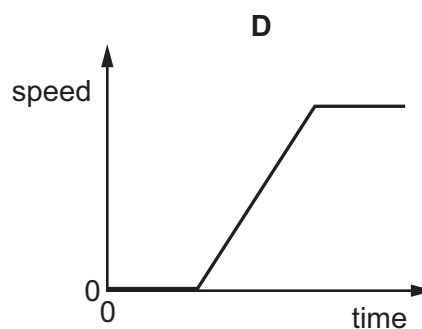
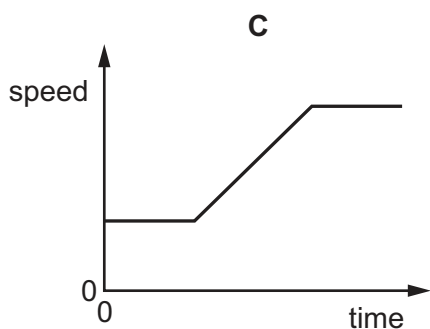
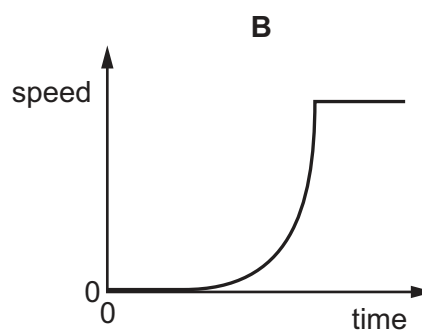
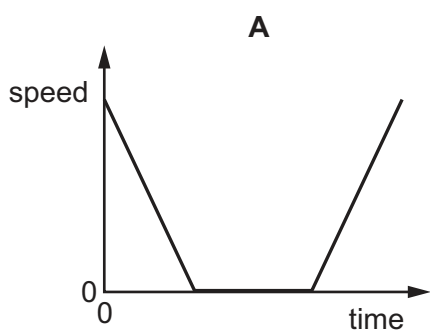

- 29 Which expression can be used to correctly calculate force?
- A mass = force / acceleration
 B mass = force \times acceleration
 C power = force \times time
 D work = force / distance
- 30 An astronaut has a weight of 160 N on the Moon where the gravitational field strength is 1.6 N/kg.
 The gravitational field strength on Mars is 3.7 N/kg.
 What is the weight of the astronaut on Mars?
- A 100 N B 160 N C 370 N D 590 N
- 31 A cat toy consists of a plastic mouse, weight 0.50 N, and a ping pong ball, suspended from the ceiling so that the toy is in equilibrium.

The mouse is 0.20 m from the pivot, P, and the ping pong ball is 0.90 m from the pivot.

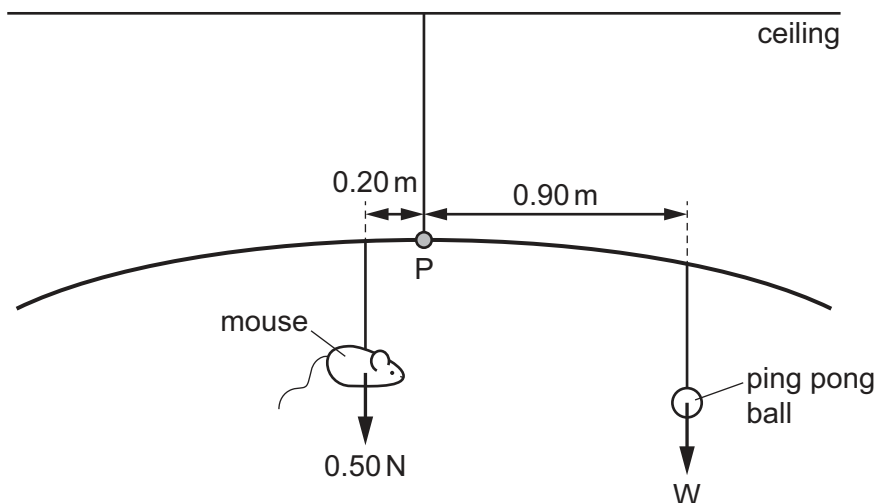

What is the weight of the ping pong ball?

- A 0.11 N B 0.22 N C 3.6 N D 9.0 N
- 32 An electric motor lifts a weight of 8 N through a height of 5 m in 4 s.
 What is the useful power developed?
- A 2.5 W B 6.4 W C 10 W D 40 W

- 33 The diagram shows an experiment to compare the thermal conductivity of four materials. Rods are made from one of each of four materials and coated in wax.

The tops of the wax-coated rods are inserted in a container of boiling water. The diagram shows the rods after two minutes.

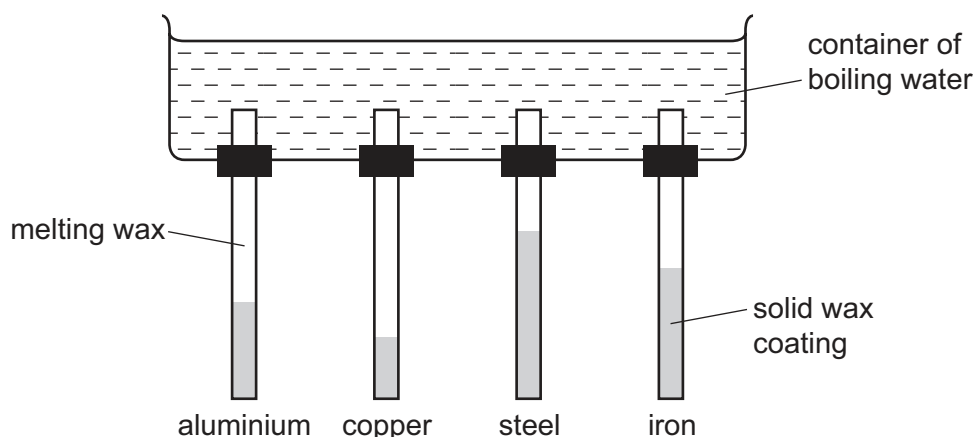

Which order of conductivity is correct?

	best conductor	→		worst conductor
A	copper	aluminium	iron	steel
B	copper	iron	aluminium	steel
C	steel	aluminium	iron	copper
D	steel	iron	aluminium	copper

- 34 A plane mirror will form an image of an object placed in front of it.

Which statement about the image is **not** correct?

- A** The image can be focused on a screen.
- B** The image is formed as far behind the mirror as the object is in front.
- C** The image is the same size as the object.
- D** The image is the same way up as the object.

- 35 A semi-circular block is made from plastic. A ray of light passes through it at the angles shown.

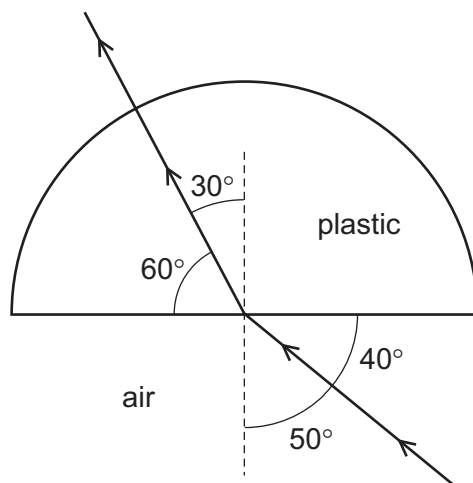

What is the refractive index of the plastic?

- A 0.74 B 1.29 C 1.53 D 1.67
- 36 The diagram shows two charged spheres, P and Q, hanging from nylon threads before and after a positively charged strip is placed between them.

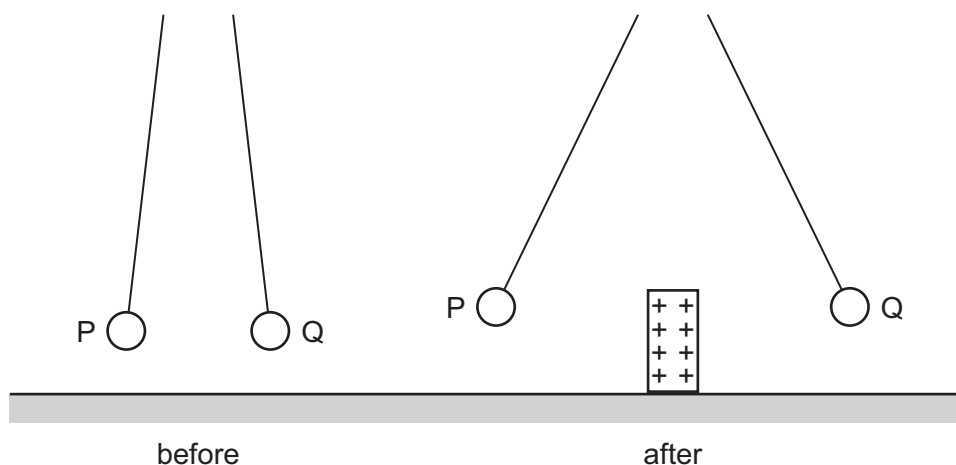

What are the charges on P and Q?

	charge on P	charge on Q
A	negative	negative
B	negative	positive
C	positive	negative
D	positive	positive

37 The diagram shows an electrical circuit.

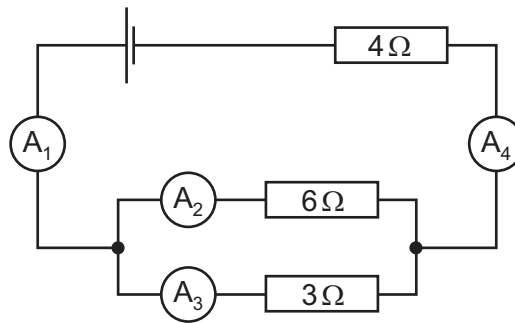

The reading on ammeter A_2 is 1 A and on A_4 is 3 A.

What are the readings on ammeters A_1 and A_3 ?

	A_1 / A	A_3 / A
A	1.5	0.5
B	2	1
C	3	1
D	3	2

38 A current of 2.0 A flows for 10 minutes through a 5Ω resistor.

Which row shows the potential difference across and the energy dissipated in the resistor?

	potential difference / V	energy dissipated / J
A	2.5	3000
B	2.5	50
C	10	12000
D	10	200

39 An atom of beryllium contains four protons and four electrons.

The nucleon number of the atom is 9.

How many neutrons are there in the atom?

- A** 1 **B** 5 **C** 9 **D** 13

40 After use, a radioactive source still contains material that is radioactive.

How may it be disposed of safely?

- A by burning the source at high temperatures
- B by burying the source deep underground
- C by cooling the source quickly to a very low temperature
- D by washing the source into a fast-flowing river

Permission to reproduce items where third-party owned material protected by copyright is included has been sought and cleared where possible. Every reasonable effort has been made by the publisher (UCLES) to trace copyright holders, but if any items requiring clearance have unwittingly been included, the publisher will be pleased to make amends at the earliest possible opportunity.

To avoid the issue of disclosure of answer-related information to candidates, all copyright acknowledgements are reproduced online in the Cambridge International Examinations Copyright Acknowledgements Booklet. This is produced for each series of examinations and is freely available to download at www.cie.org.uk after the live examination series.

Cambridge International Examinations is part of the Cambridge Assessment Group. Cambridge Assessment is the brand name of University of Cambridge Local Examinations Syndicate (UCLES), which is itself a department of the University of Cambridge.

The Periodic Table of Elements

		Group															
I	II	III	IV	V	VI	VII	VIII					VIII					
3 Li lithium 7	4 Be beryllium 9	1 H hydrogen 1	5 B boron 11	6 C carbon 12	7 N nitrogen 14	8 O oxygen 16	9 F fluorine 19	10 Ne neon 20					18 Ar argon 40				
11 Na sodium 23	12 Mg magnesium 24	<p>Key</p> <p>atomic number atomic symbol name relative atomic mass</p>										16 S sulfur 32	17 Cl chlorine 35.5	18 Ar argon 40			
19 K potassium 39	20 Ca calcium 40	21 Sc scandium 45	22 Ti titanium 48	23 V vanadium 51	24 Cr chromium 52	25 Mn manganese 55	26 Fe iron 56	27 Co cobalt 59	28 Ni nickel 59	29 Cu copper 64	30 Zn zinc 65	31 Ga gallium 70	32 Ge germanium 73	33 As arsenic 75	34 Se selenium 79	35 Br bromine 80	36 Kr krypton 84
37 Rb rubidium 85	38 Sr strontium 88	39 Y yttrium 89	40 Zr zirconium 91	41 Nb niobium 93	42 Mo molybdenum 96	43 Tc technetium —	44 Ru ruthenium 101	45 Rh rhodium 103	46 Pd palladium 106	47 Ag silver 108	48 Cd cadmium 112	49 In indium 115	50 Sn tin 119	51 Sb antimony 122	52 Te tellurium 128	53 I iodine 127	54 Xe xenon 131
55 Cs caesium 133	56 Ba barium 137	57–71 lanthanoids	72 Hf hafnium 178	73 Ta tantalum 181	74 W tungsten 184	75 Re rhenium 186	76 Os osmium 190	77 Ir iridium 192	78 Pt platinum 195	79 Au gold 197	80 Hg mercury 201	81 Tl thallium 204	82 Pb lead 207	83 Bi bismuth 209	84 Po polonium —	85 At astatine —	86 Rn radon —
87 Fr francium —	88 Ra radium —	89–103 actinoids	104 Rf rutherfordium —	105 Db dubnium —	106 Sg seaborgium —	107 Bh bohrium —	108 Hs hassium —	109 Mt meitnerium —	110 Ds darmstadtium —	111 Rg roentgenium —	112 Cn copernicium —	114 Fl flerovium —	116 Lv livermorium —	118 Og oganeson —	119 Uue unbinilium —	120 Uub unbihunium —	121 Uut untrium —

57 La lanthanum 139	58 Ce cerium 140	59 Pr praseodymium 141	60 Nd neodymium 144	61 Pm promethium —	62 Sm samarium 150	63 Eu europium 152	64 Gd gadolinium 157	65 Tb terbium 159	66 Dy dysprosium 163	67 Ho holmium 165	68 Er erbium 167	69 Tm thulium 169	70 Yb ytterbium 173	71 Lu lutetium 175
89 Ac actinium —	90 Th thorium 232	91 Pa protactinium 231	92 U uranium 238	93 Np neptunium —	94 Pu plutonium —	95 Am americium —	96 Cm curium —	97 Bk berkelium —	98 Cf californium —	99 Es einsteinium —	100 Fm fermium —	101 Md mendelevium —	102 No nobelium —	103 Lr lawrencium —

lanthanoids

actinoids

The volume of one mole of any gas is 24 dm³ at room temperature and pressure (r.t.p.).